

Curtain Track WAVE

Ceiling Fix Fitting Instructions

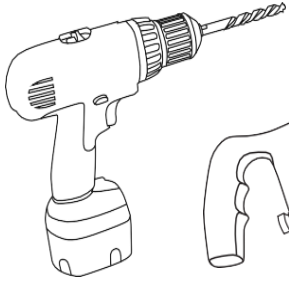

Tools you may need...



Drill

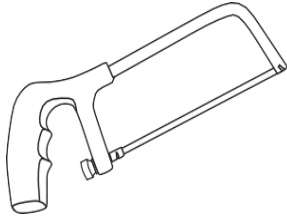

Hacksaw

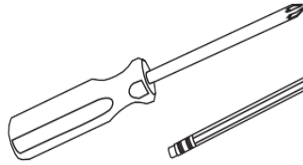

Screwdriver

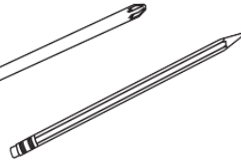

Pencil

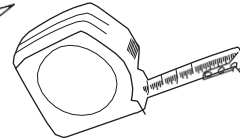

Tape Measure

how to...

fit your Ceiling Fix curtain track...

The box will include your track at the length ordered, brackets and fixings. This track is for use with wave headed curtains only.



Ceiling Fix Bracket

When you measured for your track you will have decided you were fitting to the ceiling; you will have told us this at order stage and so you will have been issued with Ceiling Fix brackets.

Step 1: Determine the position of your track brackets. We advise that the 2 outer brackets are 10cm from the end of the track, and all other brackets are spaced evenly (no further than 60cm apart) between these 2 outer brackets.

Step 2: Mark out on the ceiling, with a pencil, where you want to fit the brackets; use the brackets as a template to identify your screw points. You may want to use a straight edge or chalk-line for accuracy.

Tip: Your track should be central to the window / door recess; leave an equal gap or overhang on both sides.

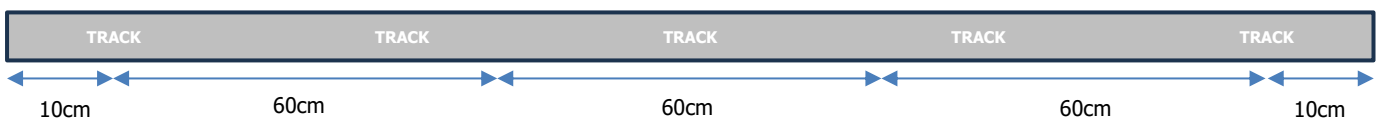

Step 3: Drill into ceiling at the marked positions with an appropriate drill bit for the type of ceiling, to a minimum depth of 40mm. Insert the plugs and push / hammer home until flush with the ceiling. Then screw each bracket into position using the screw provided.

Step 4: Offer track onto the fitted brackets, ensuring it is central to the window, with the raised lip of the track facing the room. Once your track is in the correct position, lock the brackets by turning the lever anticlockwise.

Note: If you need to remove the track, unlock the brackets by turning the lever clockwise, and gently pull the track down to release from the brackets. Always remove the curtains from the track before carrying out this step.

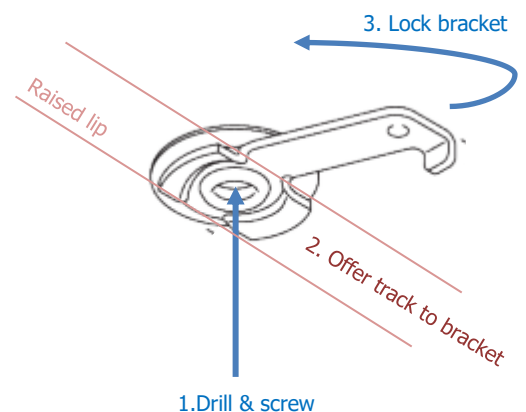

Note: If for some reason you need to shorten your track, remove one of the end caps and cut down the track with a sharp hacksaw - taking care to cut as squarely as possible. Replace the end cap once you have finished.

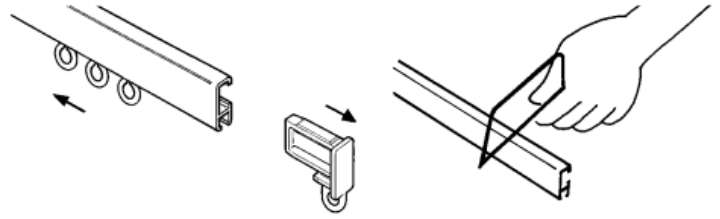

Maintenance and Cleaning

This track and its components must not be treated with aggressive cleaning products. It is best cleaned with a slightly damp cloth only.



Just Furnishings Limited

customerservice@justfurnishings.co.uk | Highlands Road, Solihull, West Midlands, B90
4NP

www.justfurnishings.co.uk

Company Reg: 05998499